

HYDRAULIC TOOLING

Wire Size	Dies for 59973-1, 69065		Dies for 69067 Flag Terminals		59975-1, 69069 With/Self-Contained Dies	Dies for 58445-1 1752788-1	Dies for 69082 1752786-1	Dies for 69097		Dies for 69099 1752868-1
	Nest	Indenter	Nest	Indenter				Nest	Indenter	
8	48126	48355	48126-48506	48355-48505	59975-1 69069	----	----	46146	46145	69216
8 H.D.	48128-1	48127-1	48128-1	48127-1	----	----	----	----	----	---
6	48128	48127	48128-48508	48127-48507	59975-1 69069	----	----	46134	46133	69217
6 H.D.	48129-1	48127-1	48129-1	48127-1	---	---	---	---	---	---
4	48129	48127	48129-48509	48127-48507	59975-1 69069	---	---	46135	46133	69218
4 H.D.	48130-1	48127-1	48130-1	48127-1	---	---	---	---	---	---
2	48130	48127	48130-48510	48127-48507	59975-1 69069	---	---	46136	46133	45433
2 H.D.	48132-1	48131-1	48132-1	48131-1	---	---	---	---	---	---
1/0	48132	48131	48132-48652	48131-48511	---	---	---	46138	46137	45436
1/0 H.D.	48133-1	48131-1	48133-1	48131-1	---	---	---	---	---	---
2/0	48133	---	48133-48805	48131-48511	---	---	---	---	---	45439
3/0	48134	48131	48134-48806	48131-48511	---	---	---	---	---	45442
4/0	300430	---	300430-48807	48131-48511	---	---	---	---	---	45445
250-300 MCM	---	---	---	---	---	48816	69911	---	---	---
300-350 MCM	---	---	---	---	---	48817	69912	---	---	---
400 MCM	---	---	---	---	---	48818	69913	---	---	---
500-600 MCM	---	---	---	---	---	48819	69914	---	---	---

SOLISTRAND* Terminals and Splices
(Refer to pages 3, 4, and 5 for application tooling and accessories.)

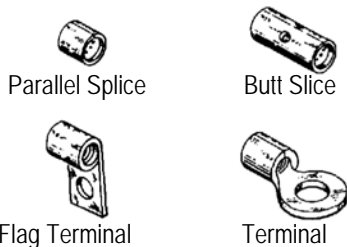

Pressure Type Wire Connector Chart (Use Type "W" Tooling)

WIRE SIZE RANGE	UL 424C LISTED	SP LR 7189 CERTIFIED
22-16 Solid or Stranded	22-16 Solid or Stranded	22-16 Solid or Stranded
16-14 Solid or Stranded	16-14 Solid or Stranded	16-14 Solid or Stranded
12-10 Solid or Stranded	12-10 Stranded	12-10 Solid or Stranded
8 Thru 600 MCM Solid or Stranded	8 Thru 600 MCM Stranded	8 Thru 4/0 Solid or Stranded

NOTE: 22-16 terminals and splices are stamped 22-18 in accordance with MIL-T-7928.

WIRE SIZE	HAND TOOLS †Long Handle ‡Heavy Head	PNEUMATIC				TAPE	
		Heads for 626	Heads for 69015	Jaws for 68068-[]	Dies for 69710-1	Dies for 69875 • Reversed •• Standard	Dies for 68250-1
26-22	69363†	---	---	---	---	68108-1	---
22-18	---	314516-1 679301-1	---	---	---	---	---
22-16	49935†	314516-1 679301-1	---	---	47812	68240-1• 68096-1 ••	---
16-14	49935†	314517-1 679301-1	---	---	47813	68241-1• 68097-1 ••	---
14-12	49592†	314518-1 679301-1	---	---	---	90566-1	---
12-10 16-14 H.D.	49935†	679301-1	---	---	47814 (Str. Wire Only)	68242-1• 68338-1 ••	---
	49965† (Flag Only)						
8	69339‡ (Str. Wire)	1338757-1	49956	68135	---	68243-1 (Single Indent)	68312-1 (Single Indent)
	69355‡		48412 (Flag Terminals)				
6	59083‡ (No Ratchet)	1338758-1	48172 48413 (Flag Terminals)	68136	---	---	68313-1 (Single Indent)
4	---	---	48173	---	---	---	---
2	---	---	48174	---	---	---	---
			48415 (Flag Terminals)				
1/0	---	---	48183	---	---	---	---

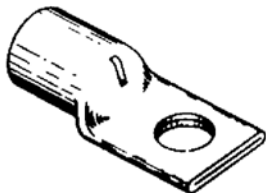
AMPOWER* Terminals and Splices

Terminal

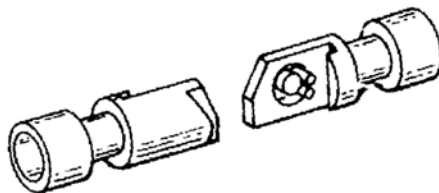

Quick Disconnect



Parallel Splice



Butt Slice

Pressure Type Wire Connector Chart
 (Use Type "C" Tooling)

WIRE SIZE RANGE	UL 424C LISTED	SA LR 7189 CERTIFIED
6 thru 1000 MCM	6 thru 1000 MCM Stranded	6 thru 1000 MCM Stranded

WIRE SIZE	HYDRAULIC TOOLING (Use Power Unit 69120-[] or 314979-1 †Quick Disconnect Terminals Only)				
	Dies for 69099 1752868-1	Dies for 69082 1752786-1	Dies for 69065 59973-1	Dies for 58445-1 1752788-1	Dies for 68073-2
6	69133-1	---	---	---	---
4	69134-2	---	---	---	---
2	46765-3	---	46321-3	---	---
1/0	46766-2	---	46322-2	---	---
	68361-1 †(with locator)				
2/0	46767-2	---	46323-2	---	---
	68253-1 †(with locator)				
3/0	46749-2	---	46324-2	---	---
	59867-1 †(with locator)				
4/0	46750-2	---	46325-2	---	---
	68304-1 †(with locator)				
250 MCM	46751-2 68203-1†	---	---	46326-2	---
300 MCM	46752-2	---	---	---	---
400 MCM	46753-2	69653 68204-1†	---	---	---
500 MCM	---	46755-2 68206-1†	---	---	---
600 MCM	---	46756-2	---	---	---
600 H.D.	---	59870-1	---	---	---
700 MCM	---	46757-2	---	---	---
800 MCM	---	46758-2	---	---	---
900 MCM	---	46759-2	---	---	---
1000 MCM	---	46760-2	---	---	---
1250 MCM	---	---	---	---	68114-1
1500 MCM	---	---	---	---	68282-1

TOOLING AND ACCESSORIES

Hydraulic Crimping Heads

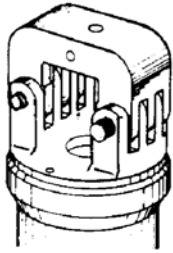

58445-1
1752788-1

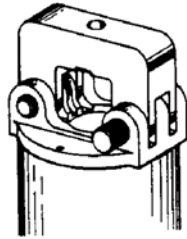

69065



69097



69082
1752786-1

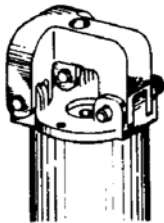

69067

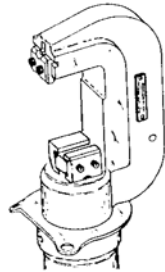

68073-2



69069



69099
1752868-1

Hand Tools

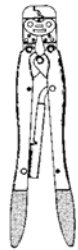

Long and
Short Handle



69710-1



Heavy Head

TOOLING AND ACCESSORIES

Hydraulic

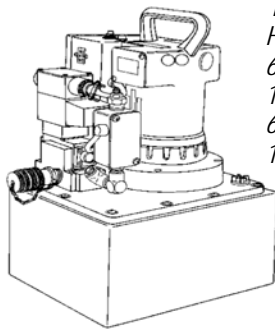

*DYNA-CRIMP**
Hydraulic Power Units
69120-1 (115 VAC - 60 Hz)
1804700-1 (115 VAC - 60 Hz)
69120-2 (230 VAC - 60 Hz)
1804700-2 (230 VAC - 60 Hz)

Handle Control W/Hose and Cord 59907-[] and 1901775-[]

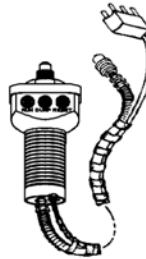

Foot Control 68284-1

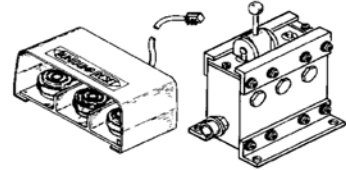

Hose Assy W/Crimping Head Coupling

3-Way Multidirectional Valve 59220 (No Safety Sw) 59220-2 (W/Safety Sw)

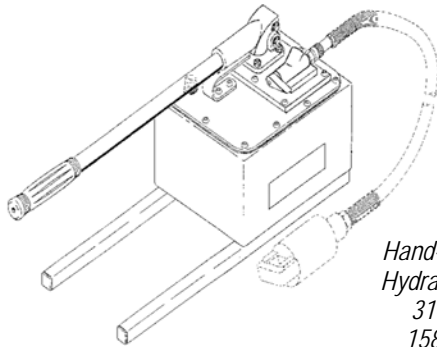

Hand-Operated Hydraulic Pump 314979-1 1583661-1

59909-[] 1583662-[]

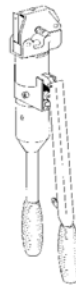

Hand Tool 59975-1



Hand Tool 59973-1

Tape Machines

AMP-TAPETRONIC Machine 68250-1*

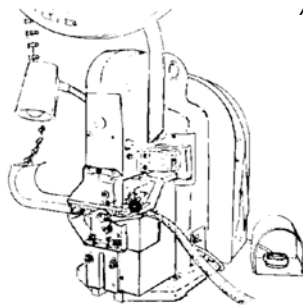

AMP-TAPETRONIC Machine 69875*

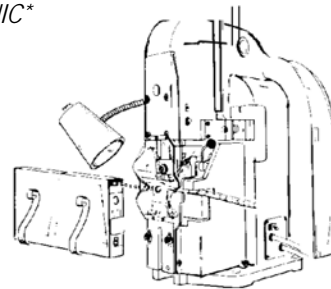

Pneumatic

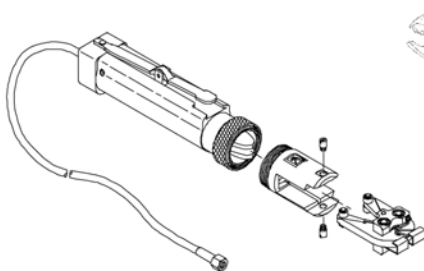

69015

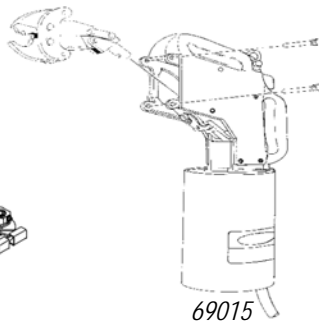

68068

REVISION SUMMARY:

Corrected die part number for hydraulic tooling in table on page 1.